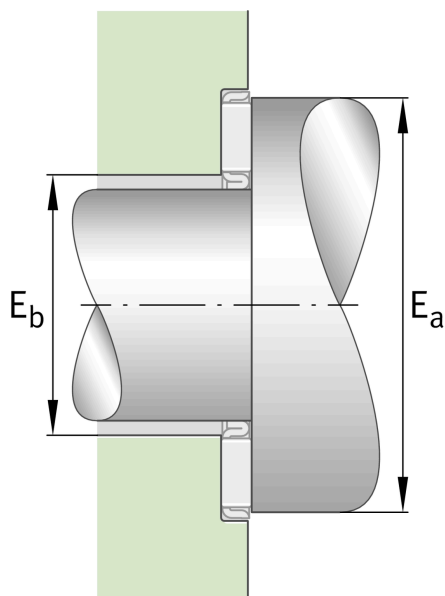
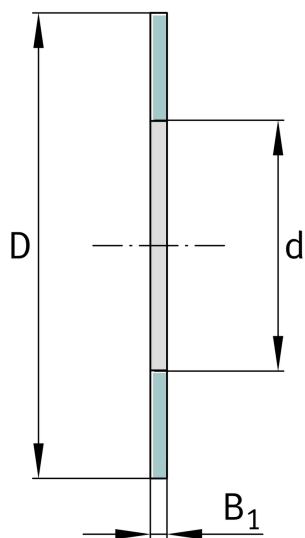
**AS7095**

Axial bearing washer

Schaeffler ID:
0000197040000Axial bearing washers, suitable for AXK
and K811, to DIN 5405-3/ISO 303

Technical information

**Main Dimensions & Performance Data**

d	70 mm	Bore diameter bearing washer
D	95 mm	Outside diameter bearing washer
B ₁	1 mm	Height bearing washer
	23.8 g	Weight